

## STRADA-S

Side emitter beam

### TECHNICAL SPECIFICATIONS:

Dimensions	19.6 x 15.5 mm
Height	6.9 mm
Fastening	pin, screw
Colour	clear
Box size	480 x 280 x 300 mm
Box weight	3.5 kg
Quantity in Box	2880 pcs
ROHS compliant	yes 



### MATERIAL SPECIFICATIONS:

Component	Type	Material	Colour
STRADA-S	Lens	PMMA	clear

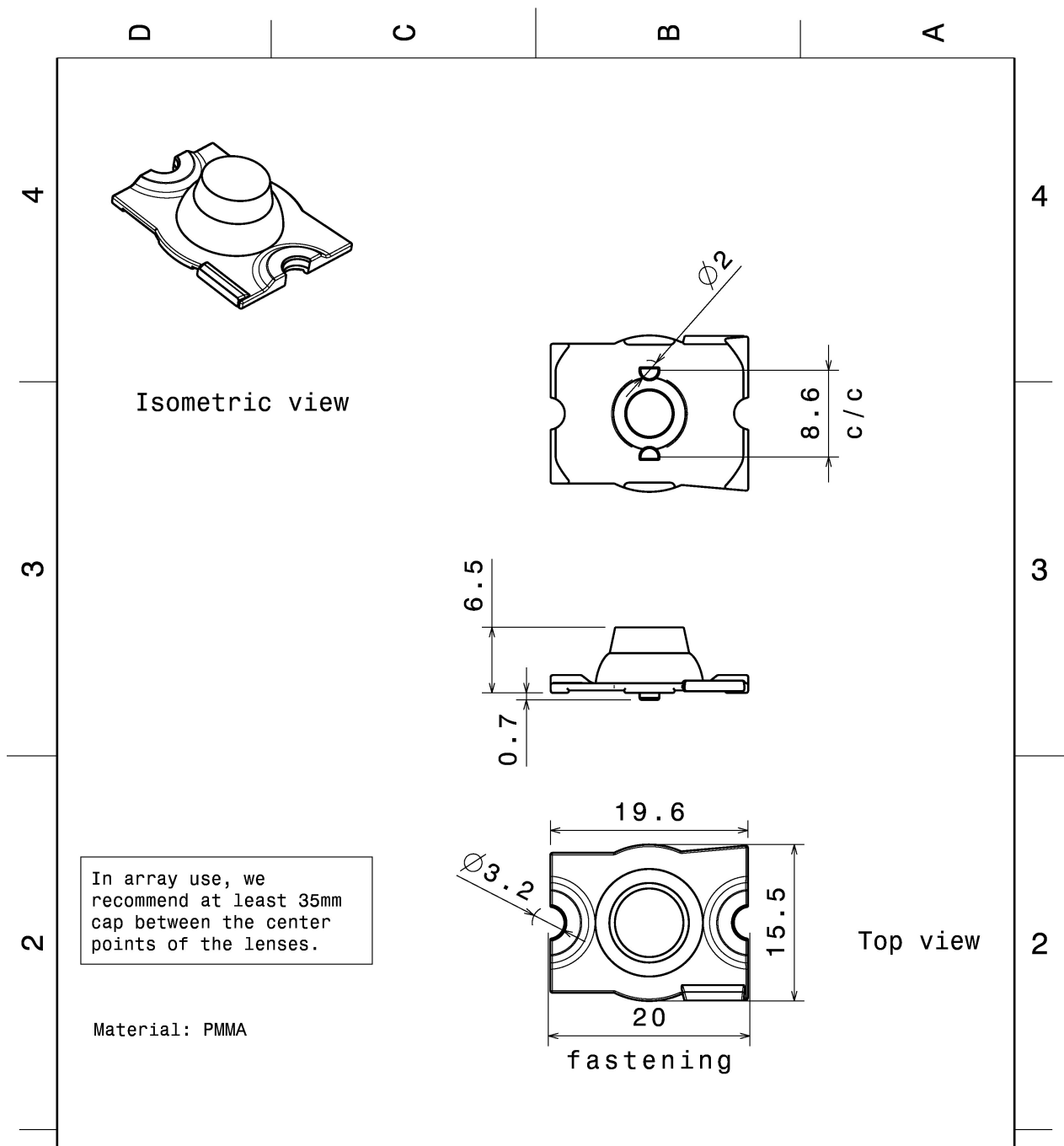

This drawing is our property. It can't be reproduced or communicated without our written agreement.				DRAWING TITLE	
DRAWN BY	DATE	Datasheet Strada-S lens			
p	18.12.2009	SIZE	DRAWING NUMBER	REV	
CHECKED BY	DATE	A4	C11249	1	
DESIGNED BY	DATE	SCALE	WEIGHT (g)	SHEET	1/1
o1	18.12.2009	2:1			

### PHOTOMETRIC DATA (MEASURED):



LED XP-E  
FWHM 144.0 + 168.0°  
Efficiency 93 %  
Peak intensity 0.470 cd/lm  
Required components:

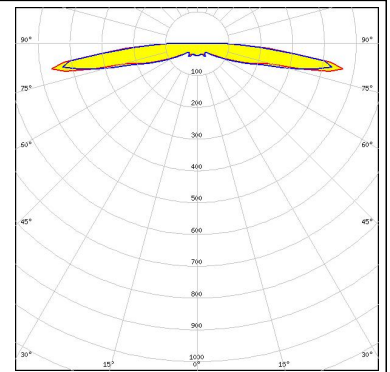

LED XP-G  
FWHM 144.0 + 176.0°  
Efficiency 93 %  
Peak intensity 0.350 cd/lm  
Required components:

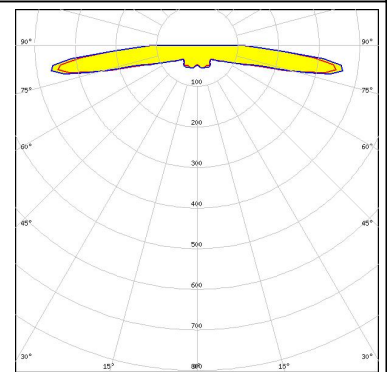

LED XP-G2  
FWHM 169.0°  
Efficiency 94 %  
Peak intensity 0.480 cd/lm  
Required components:

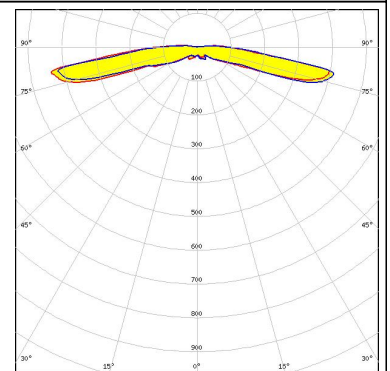

LED LUXEON Rebel  
FWHM 162.0 + 138.0°  
Efficiency 93 %  
Peak intensity 0.380 cd/lm  
Required components:

### PHOTOMETRIC DATA (MEASURED):



LED LUXEON Rebel ES  
FWHM 137.0 + 166.0°  
Efficiency 93 %  
Peak intensity 0.320 cd/lm  
Required components:

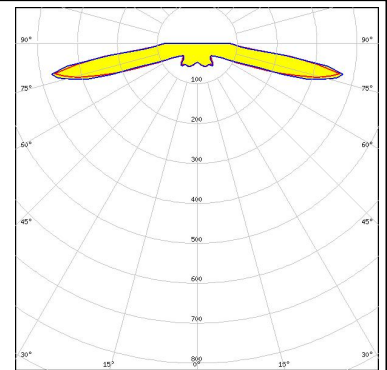

LED NCSxx19A  
FWHM 168.0 + 138.0°  
Efficiency 93 %  
Peak intensity 0.360 cd/lm  
Required components:



LED NVSxx19A  
FWHM 162.0 + 138.0°  
Efficiency 93 %  
Peak intensity cd/lm  
Required components:



LED Oslon SSL 150  
FWHM 146.0 + 170.0°  
Efficiency 93 %  
Peak intensity 0.440 cd/lm  
Required components:

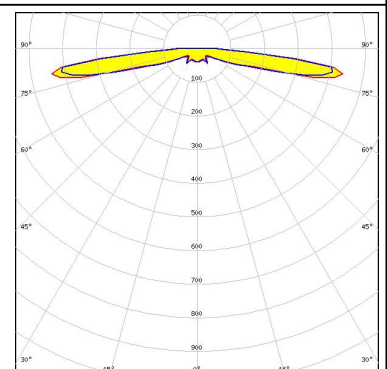

## PHOTOMETRIC DATA (MEASURED):

**OSRAM**  
Opto Semiconductors

LED Oslon SSL 80  
FWHM 161.0°  
Efficiency 93 %  
Peak intensity 0.600 cd/lm  
Required components:

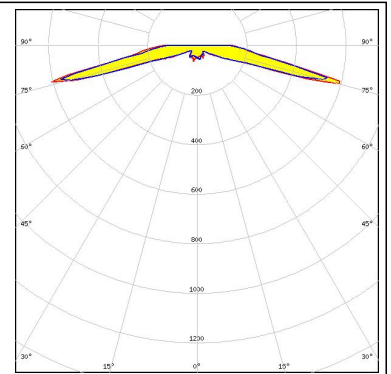

## PHOTOMETRIC DATA (SIMULATED):

### LUMILEDS

LED LUXEON A  
FWHM 144.0 + 176.0°  
Efficiency %  
Peak intensity cd/Im  
Required components:

### SEAGUR SEOUL SEMICONDUCTOR

LED Z5  
FWHM 144.0 + 176.0°  
Efficiency %  
Peak intensity cd/Im  
Required components:

### SHARP

LED Double Dome (GM2BB)  
FWHM 144.0 + 176.0°  
Efficiency %  
Peak intensity cd/Im  
Required components:

### GENERAL INFORMATION:

NOTE: The typical beam angle will be changed by different color, chip size and chip position tolerance. The typical total beam angle is the full angle measured where the luminous intensity is half of the peak value.

### MATERIALS:

As part of our continuous research and improvement processes, and to ensure the best possible quality and availability of our products, LEDiL reserves the right to change material grades without notice.

### PRODUCT DATA USER AGREEMENT AND DISCLAIMER:

The measured data in the provided downloadable LEDiL Product Datasheets and Mechanical 2D-Drawings is rounded and provided as reference for planning. LEDiL Oy's optical specifications have been verified by conducting performance testing of the products in accordance with the company's quality system. The reported data are averaged results of multiple measurements with typical variation. LEDiL Oy reserves the right to without prior notification make changes and improvements to its products.

LEDiL Oy assumes neither warranty, nor guarantee nor any other liability of any kind for the contents and correctness of the provided data. The provided data has been generated with highest diligence but the provided data may in reality not represent the complete possible variation range of all intrinsic parameters. Therefore, in certain cases a deviation from the provided data could occur.

LEDiL Oy reserves the right to undertake technical changes of its products without further notification which could lead to changes in the provided data. LEDiL Oy assumes no liability of any kind for the possible deviation from any provided data or any other damage resulting from the usage of the provided data.

The user agrees to this disclaimer and user agreement with the download or usage of the provided files.

#### LEDiL Oy

Joensuunkatu 13  
FI-24240 SALO  
Finland

#### LEDiL Inc.

228 West Page Street  
Suite D  
Sycamore IL 60178  
USA

#### Local sales and technical support

[www.ledil.com/  
where\\_to\\_buy](http://www.ledil.com/where_to_buy)

#### Shipping locations

Salo, Finland  
Hong Kong, China

#### Distribution Partners

[www.ledil.com/  
where\\_to\\_buy](http://www.ledil.com/where_to_buy)