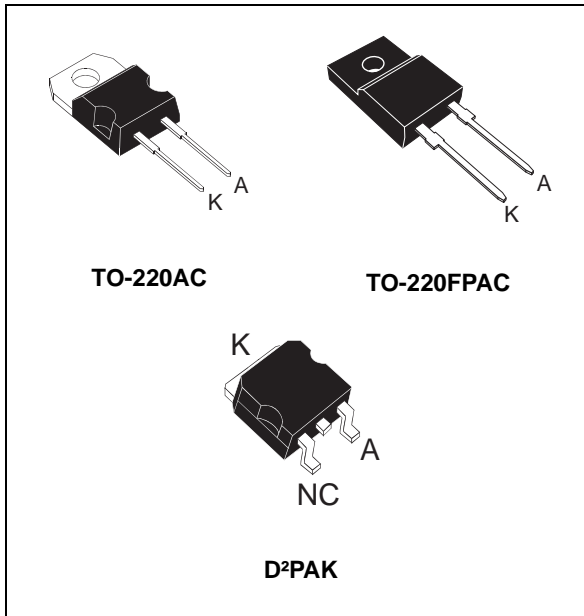

**Turbo 2 ultrafast high voltage rectifier**

Datasheet - production data

**Description**

The STTH15L06, which is using ST Turbo 2 600 V technology, is specially suited for use in switching power supplies, and industrial applications, as rectification and discontinuous mode PFC boost diode.

**Table 1. Device summary**

Symbol	Value
$I_{F(AV)}$	Up to 20 A
$V_{RRM}$	600 V
$T_j$	175 °C
$V_F$ (typ)	0.95 V
$t_{rr}$ (max)	55 ns

**Features**

- Ultrafast switching
- Low reverse recovery current
- Reduces switching and conduction losses
- Low thermal resistance

# 1 Characteristics

**Table 2. Absolute ratings (limiting values)**

Symbol	Parameter		Value	Unit	
$V_{RRM}$	Repetitive peak reverse voltage		600	V	
$I_{F(RMS)}$	Forward rms current		30	A	
$I_{F(AV)}$	Average forward current $\delta = 0.5$	TO-220AC / D <sup>2</sup> PAK	$T_c = 140\text{ °C}$ $T_c = 120\text{ °C}$	15 20	A
		TO-220FPAC	$T_c = 90\text{ °C}$	15	
$I_{FSM}$	Surge non repetitive forward current	$t_p = 10\text{ ms sinusoidal}$	200	A	
$T_{stg}$	Storage temperature range		-65 to + 175	°C	
$T_j$	Maximum operating junction temperature		175	°C	

**Table 3. Thermal parameter**

Symbol	Parameter		Maximum	Unit
$R_{th(j-c)}$	Junction to case	TO-220AC / D <sup>2</sup> PAK	1.7	°C/W
		TO-220FPAC	4.0	

**Table 4. Static electrical characteristics**

Symbol	Parameter	Test conditions		Min.	Typ.	Max.	Unit
$I_R^{(1)}$	Reverse leakage current	$T_j = 25\text{ °C}$	$V_R = V_{RRM}$			15	$\mu\text{A}$
		$T_j = 150\text{ °C}$			40	400	
$V_F^{(2)}$	Forward voltage drop	$T_j = 25\text{ °C}$	$I_F = 15\text{ A}$			1.55	V
		$T_j = 150\text{ °C}$			0.95	1.2	

1. Pulse test:  $t_p = 5\text{ ms}$ ,  $\delta < 2\%$
2. Pulse test:  $t_p = 380\text{ }\mu\text{s}$ ,  $\delta < 2\%$

To evaluate the maximum conduction losses use the following equation:

$$P = 0.94 \times I_{F(AV)} + 0.017 I_{F(RMS)}^2$$

Table 5. Dynamic electrical characteristics

Symbol	Parameter	Test conditions		Min.	Typ.	Max.	Unit
$t_{rr}$	Reverse recovery time	$T_j = 25\text{ }^\circ\text{C}$	$I_F = 0.5\text{ A}, I_{rr} = 0.25\text{ A}, I_R = 1\text{ A}$			55	ns
			$I_F = 1\text{ A}, \frac{dI_F}{dt} = 50\text{ A}/\mu\text{s}, V_R = 30\text{ V}$		60	85	
$I_{RM}$	Reverse recovery current	$T_j = 125\text{ }^\circ\text{C}$	$I_F = 15\text{ A}, \frac{dI_F}{dt} = 100\text{ A}/\mu\text{s}, V_R = 400\text{ V}$		8.5	12	A
$t_{fr}$	Forward recovery time	$T_j = 25\text{ }^\circ\text{C}$	$I_F = 15\text{ A}, \frac{dI_F}{dt} = 100\text{ A}/\mu\text{s}$			300	ns
$V_{FP}$	Forward recovery voltage					3	V
			$V_{FR} = 1.1 \times V_{Fmax}$				

Figure 1. Conduction losses versus average current

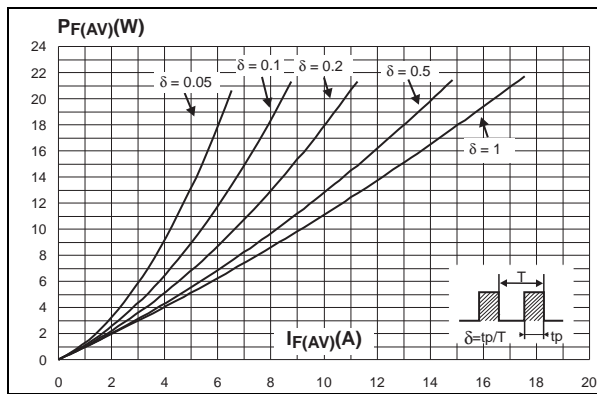

Figure 2. Forward voltage drop versus forward current

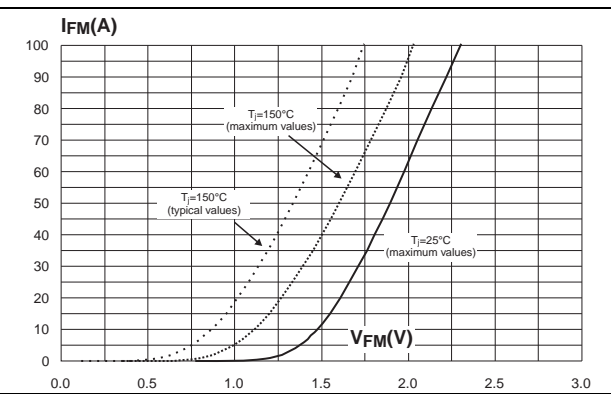

Figure 3. Relative variation of thermal impedance junction to case versus pulse duration (TO-220AC, D<sup>2</sup>PAK)

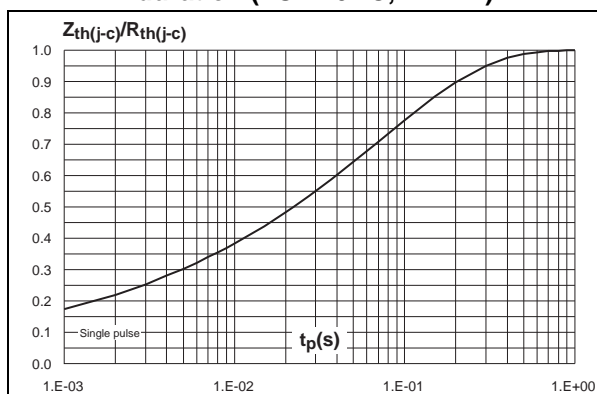

Figure 4. Relative variation of thermal impedance junction to case versus pulse duration (TO-220FPAC)

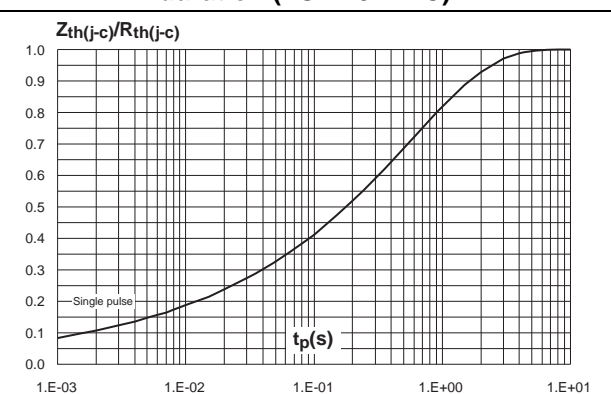

Figure 5. Peak reverse recovery current versus  $di_F/dt$  (90 % confidence)

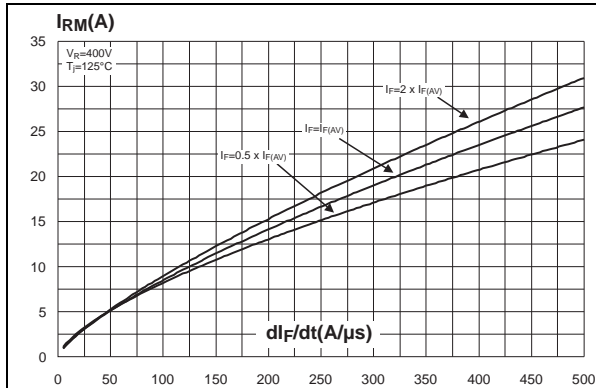

Figure 6. Reverse recovery time versus  $di_F/dt$  (90 % confidence)

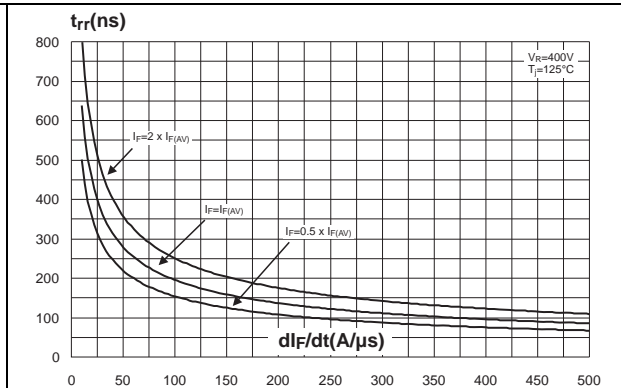

Figure 7. Reverse recovery charges versus  $di_F/dt$  (90 % confidence)

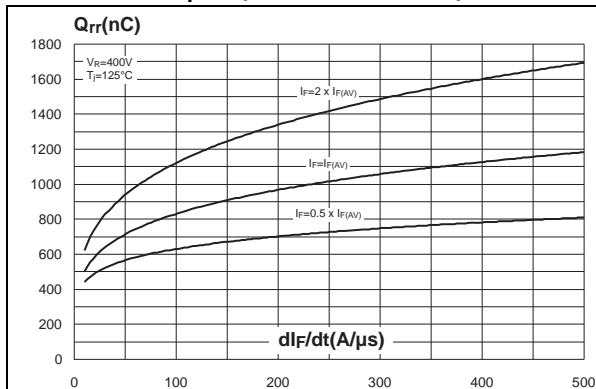

Figure 8. Softness factor versus  $di_F/dt$  (typical values)

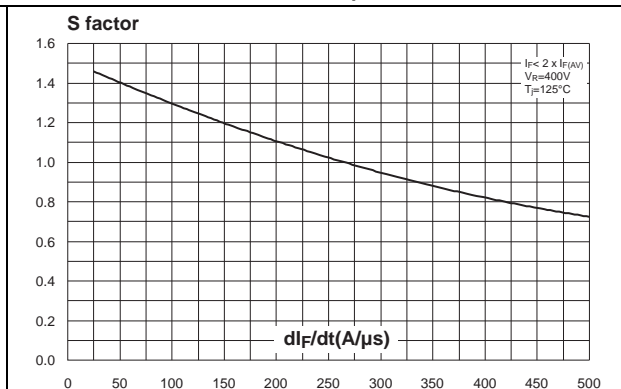

Figure 9. Relative variations of dynamic parameters versus junction temperature

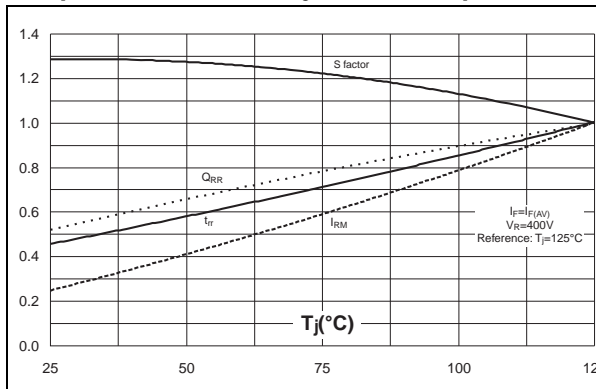
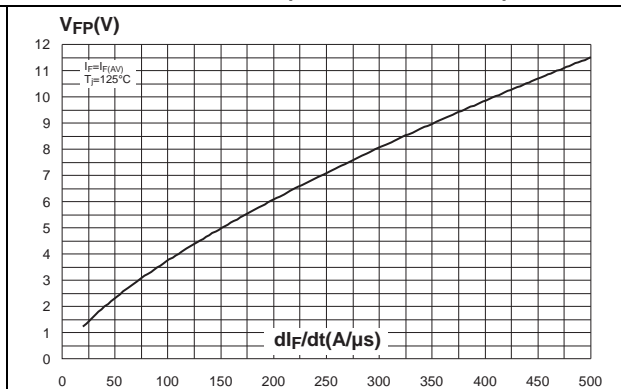
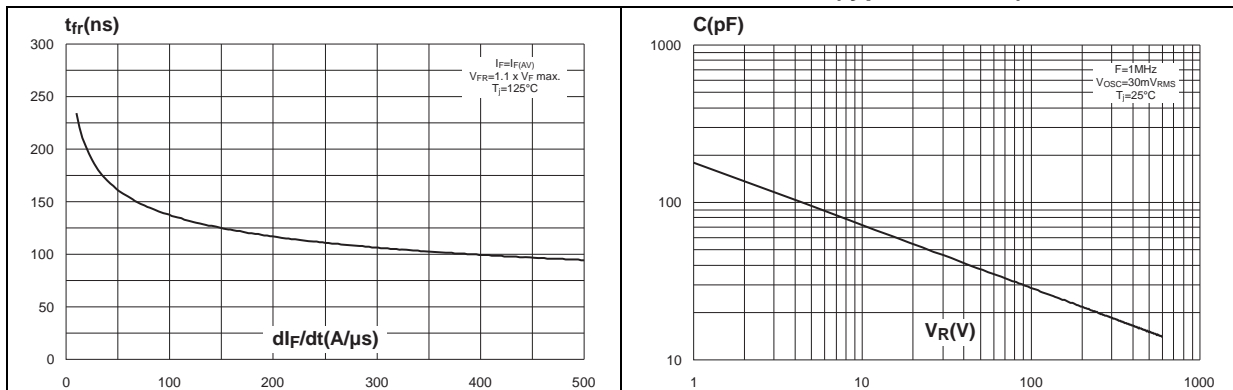

Figure 10. Transient peak forward voltage versus  $di_F/dt$  (90 % confidence)



**Figure 11. Forward recovery time versus  $di_F/dt$  (90 % confidence)**      **Figure 12. Junction capacitance versus reverse voltage applied (typical values)**



**Figure 13. Thermal resistance junction to ambient versus copper surface under tab (Epoxy printed circuit board FR4 copper thickness = 35  $\mu$ m) (D<sup>2</sup>PAK)**

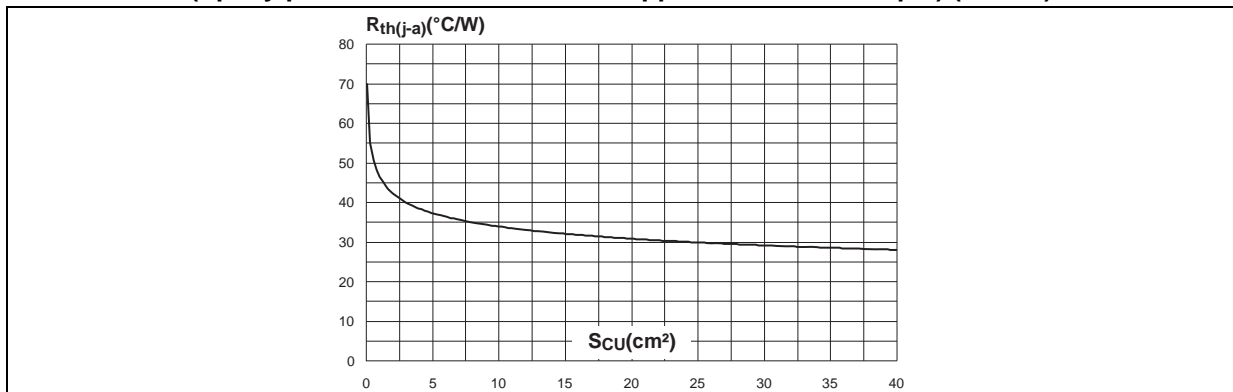

## 2 Package information

- Epoxy meets UL94, V0
- Cooling method: by conduction (C)
- Recommended torque value: 0.4 to 0.6 N·m

In order to meet environmental requirements, ST offers these devices in different grades of ECOPACK® packages, depending on their level of environmental compliance. ECOPACK® specifications, grade definitions and product status are available at: [www.st.com](http://www.st.com). ECOPACK® is an ST trademark.

Table 6. TO-220AC dimensions

Ref.	Dimensions			
	Millimeters		Inches	
	Min.	Max.	Min.	Max.
A	4.40	4.60	0.173	0.181
C	1.23	1.32	0.048	0.051
D	2.40	2.72	0.094	0.107
E	0.49	0.70	0.019	0.027
F	0.61	0.88	0.024	0.034
F1	1.14	1.70	0.044	0.066
G	4.95	5.15	0.194	0.202
H2	10.00	10.40	0.393	0.409
L2	16.40 typ.		0.645 typ.	
L4	13.00	14.00	0.511	0.551
L5	2.65	2.95	0.104	0.116
L6	15.25	15.75	0.600	0.620
L7	6.20	6.60	0.244	0.259
L9	3.50	3.93	0.137	0.154
M	2.6 typ.		0.102 typ.	
Dia. I	3.75	3.85	0.147	0.151

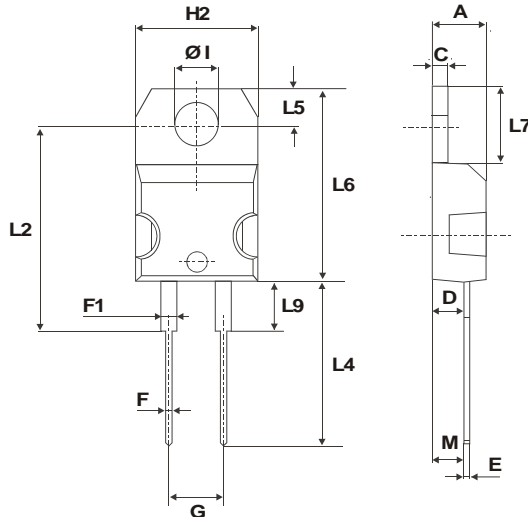

Table 7. TO-220FPAC dimensions

Ref.	Dimensions			
	Millimeters		Inches	
	Min.	Max.	Min.	Max.
A	4.4	4.6	0.173	0.181
B	2.5	2.7	0.098	0.106
D	2.5	2.75	0.098	0.108
E	0.45	0.70	0.018	0.027
F	0.75	1	0.030	0.039
F1	1.15	1.70	0.045	0.067
G	4.95	5.20	0.195	0.205
G1	2.4	2.7	0.094	0.106
H	10	10.4	0.393	0.409
L2	16 Typ.		0.63 Typ.	
L3	28.6	30.6	1.126	1.205
L4	9.8	10.6	0.386	0.417
L5	2.9	3.6	0.114	0.142
L6	15.9	16.4	0.626	0.646
L7	9.00	9.30	0.354	0.366
Dia.	3.00	3.20	0.118	0.126

Table 8. D<sup>2</sup>PAK dimensions

Ref.	Dimensions			
	Millimeters		Inches	
	Min.	Max.	Min.	Max.
A	4.40	4.60	0.173	0.181
A1	2.49	2.69	0.098	0.106
A2	0.03	0.23	0.001	0.009
B	0.70	0.93	0.027	0.037
B2	1.14	1.70	0.045	0.067
C	0.45	0.60	0.017	0.024
C2	1.23	1.36	0.048	0.054
D	8.95	9.35	0.352	0.368
E	10.00	10.40	0.393	0.409
G	4.88	5.28	0.192	0.208
L	15.00	15.85	0.590	0.624
L2	1.27	1.40	0.050	0.055
L3	1.40	1.75	0.055	0.069
M	2.40	3.20	0.094	0.126
R	0.40 typ.		0.016 typ.	
V2	0°	8°	0°	8°

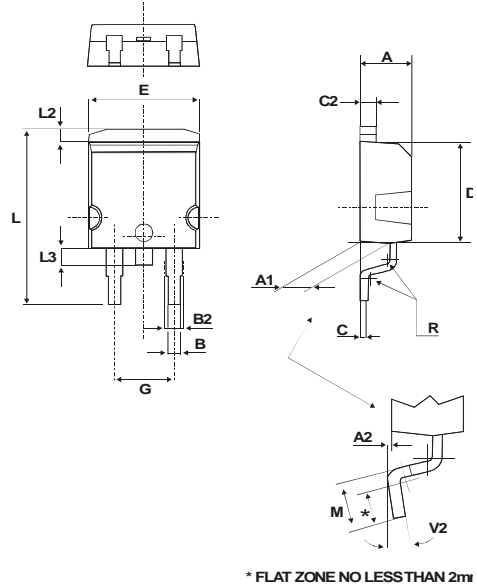
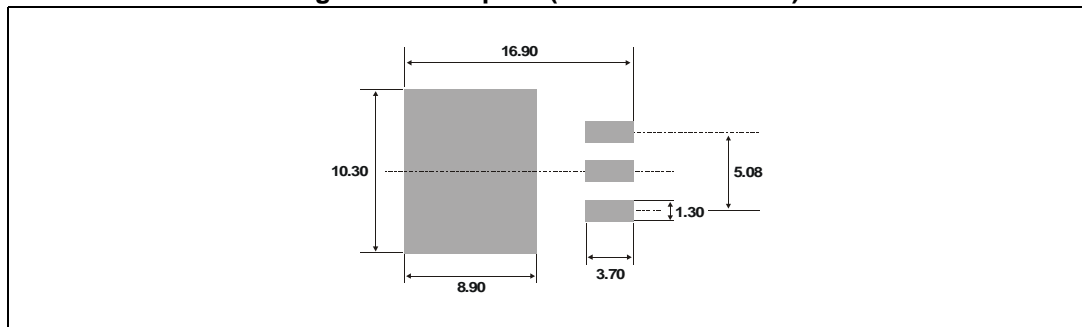

Figure 14. Footprint (dimensions in mm)





### 3 Ordering information

**Table 9. Ordering information**

Order code	Marking	Package	Weight	Base qty	Delivery mode
STTH15L06D	STTH15L06D	TO-220AC	1.90 g	50	Tube
STTH15L06G	STTH15L06G	D <sup>2</sup> PAK	1.48 g	50	Tube
STTH15L06G-TR	STTH15L06G	D <sup>2</sup> PAK	1.48 g	1000	Tape and reel
STTH15L06FP	STTH15L06FP	TO-220FPAC	1.70 g	50	Tube

### 4 Revision history

**Table 10. Document revision history**

Date	Revision	Changes
07-Sep-2004	1	First issue
15-Jul-2011	2	Updated I <sub>FSM</sub> from 130 A to 150 A.
01-Apr-2014	3	Updated I <sub>FSM</sub> from 150 A to 200 A.

**Please Read Carefully:**

Information in this document is provided solely in connection with ST products. STMicroelectronics NV and its subsidiaries ("ST") reserve the right to make changes, corrections, modifications or improvements, to this document, and the products and services described herein at any time, without notice.

All ST products are sold pursuant to ST's terms and conditions of sale.

Purchasers are solely responsible for the choice, selection and use of the ST products and services described herein, and ST assumes no liability whatsoever relating to the choice, selection or use of the ST products and services described herein.

No license, express or implied, by estoppel or otherwise, to any intellectual property rights is granted under this document. If any part of this document refers to any third party products or services it shall not be deemed a license grant by ST for the use of such third party products or services, or any intellectual property contained therein or considered as a warranty covering the use in any manner whatsoever of such third party products or services or any intellectual property contained therein.

**UNLESS OTHERWISE SET FORTH IN ST'S TERMS AND CONDITIONS OF SALE ST DISCLAIMS ANY EXPRESS OR IMPLIED WARRANTY WITH RESPECT TO THE USE AND/OR SALE OF ST PRODUCTS INCLUDING WITHOUT LIMITATION IMPLIED WARRANTIES OF MERCHANTABILITY, FITNESS FOR A PARTICULAR PURPOSE (AND THEIR EQUIVALENTS UNDER THE LAWS OF ANY JURISDICTION), OR INFRINGEMENT OF ANY PATENT, COPYRIGHT OR OTHER INTELLECTUAL PROPERTY RIGHT.**

**ST PRODUCTS ARE NOT DESIGNED OR AUTHORIZED FOR USE IN: (A) SAFETY CRITICAL APPLICATIONS SUCH AS LIFE SUPPORTING, ACTIVE IMPLANTED DEVICES OR SYSTEMS WITH PRODUCT FUNCTIONAL SAFETY REQUIREMENTS; (B) AERONAUTIC APPLICATIONS; (C) AUTOMOTIVE APPLICATIONS OR ENVIRONMENTS, AND/OR (D) AEROSPACE APPLICATIONS OR ENVIRONMENTS. WHERE ST PRODUCTS ARE NOT DESIGNED FOR SUCH USE, THE PURCHASER SHALL USE PRODUCTS AT PURCHASER'S SOLE RISK, EVEN IF ST HAS BEEN INFORMED IN WRITING OF SUCH USAGE, UNLESS A PRODUCT IS EXPRESSLY DESIGNATED BY ST AS BEING INTENDED FOR "AUTOMOTIVE, AUTOMOTIVE SAFETY OR MEDICAL" INDUSTRY DOMAINS ACCORDING TO ST PRODUCT DESIGN SPECIFICATIONS. PRODUCTS FORMALLY ESCC, QML OR JAN QUALIFIED ARE DEEMED SUITABLE FOR USE IN AEROSPACE BY THE CORRESPONDING GOVERNMENTAL AGENCY.**

Resale of ST products with provisions different from the statements and/or technical features set forth in this document shall immediately void any warranty granted by ST for the ST product or service described herein and shall not create or extend in any manner whatsoever, any liability of ST.

ST and the ST logo are trademarks or registered trademarks of ST in various countries.

Information in this document supersedes and replaces all information previously supplied.

The ST logo is a registered trademark of STMicroelectronics. All other names are the property of their respective owners.

© 2014 STMicroelectronics - All rights reserved

STMicroelectronics group of companies

Australia - Belgium - Brazil - Canada - China - Czech Republic - Finland - France - Germany - Hong Kong - India - Israel - Italy - Japan - Malaysia - Malta - Morocco - Philippines - Singapore - Spain - Sweden - Switzerland - United Kingdom - United States of America

[www.st.com](http://www.st.com)