



Grayhill, Inc.

70M-ODC24B

Part Number: 70M-ODC24B

 Manufacturer / Brand:
 Mombamomba ny vokatra

 Datasheets:
[70M-ODC24B.pdf](#)

RoHS Status

Stock Condition

Ship From

Shipment Way

Grayhill, Inc.

DC OUTPUT MODULE 3A

 70M-ODC24B.pdf

 Lead free / RoHS compliant

6773 pcs stock

Hong Kong

DHL/Fedex/TNT/UPS/EMS

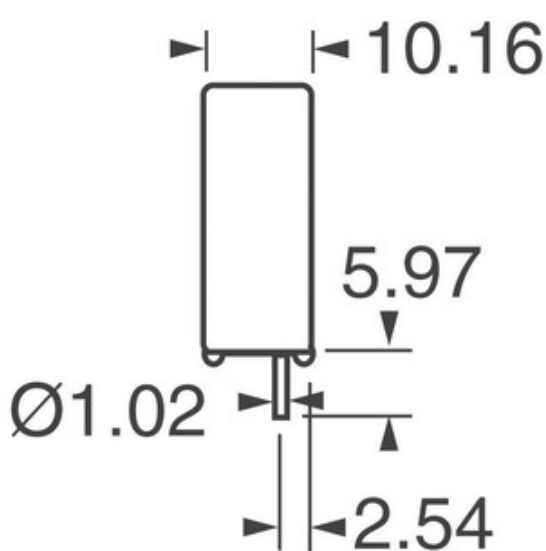

Mety ho sary ny sary. Jereo manokana ny tsipiriany momba ny vokatra.

MANGATAHA FAMPISEHOANA









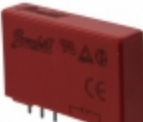

Specifications of 70M-ODC24B

PART NUMBER	70M-ODC24B
MANUFACTURER	Grayhill, Inc.
DESCRIPTION	DC OUTPUT MODULE 3A
LEAD FREE STATUS / ROHS STATUS	Lead free / RoHS compliant
QUANTITY AVAILABLE	6773 pcs
TAKELA-DAZA	70M-ODC24B.pdf
VOLTAGE - OUTPUT	3 ~ 60VDC
VOLTAGE - INPUT	24VDC
TYPE	DC Output Module
MIVERENA AMIN'NY FOTOANA	0.075ms
HANAFOANA NY FOTOANA	0.50ms
STYLE	Mini
SERIES	70
NY HAAVON'NY FAHITAN-TORY (MSL)	1 (Unlimited)
LEAD FREE STATUS / ROHS STATUS	Lead free / RoHS Compliant
TOETOETRA	-
DETAILED DESCRIPTION	DC Output Module Output Module 3A 3 ~ 60VDC Output 24VDC Supply
CURRENT - OUTPUT	3A
CURRENT - INPUT	9mA
COLOR	Red

Related Tags

Grayhill, Inc. 70M-ODC24B	70M-ODC24B Distributor	70M-ODC24B Supplier
70M-ODC24B Price	70M-ODC24B Pictures	70M-ODC24B Image
70M-ODC24B PDF Datasheet	70M-ODC24B Download Datasheet	70M-ODC24B Datasheet
70M-ODC24B Stock	Buy 70M-ODC24B	Buy Grayhill, Inc. 70M-ODC24B
Grayhill, Inc. 70M-ODC24B	Grayhill, Inc. Supplier	Grayhill, Inc. Distributor
Grayhill, Inc. 70M-ODC24B	Grayhill Inc. 70M-ODC24B	

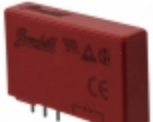
Related Products

 <p>70M-OAC5A Manufacturers: Grayhill, Inc. Description: AC OUTPUT MODULE 3A Ao amin'ny staoky: 8199 pcs</p> <p>RFQ</p>	 <p>70M-ODC24 Manufacturers: Grayhill, Inc. Description: DC OUTPUT MODULE 3A Ao amin'ny staoky: 8219 pcs</p> <p>RFQ</p>
 <p>70M-ODC24R Manufacturers: Grayhill, Inc. Description: DC OUTPUT MODULE 500MA Ao amin'ny staoky: 4650 pcs</p> <p>RFQ</p>	 <p>70M00000Z Manufacturers: Hamlin / Littelfuse Description: FUSE CARTRIDGE 8A 125VAC/300VDC Ao amin'ny staoky: 5905 pcs</p> <p>RFQ</p>
 <p>70M-ODC15 Manufacturers: Grayhill, Inc. Description: DC OUTPUT MODULE 3A Ao amin'ny staoky: 8301 pcs</p> <p>RFQ</p>	 <p>70M-OAC5 Manufacturers: Grayhill, Inc. Description: AC OUTPUT MODULE 3A Ao amin'ny staoky: 8461 pcs</p> <p>RFQ</p>
 <p>70M-OAC5A-L Manufacturers: Grayhill, Inc. Description: AC OUTPUT MODULE 3A Ao amin'ny staoky: 6556 pcs</p> <p>RFQ</p>	 <p>70M-ODC5B Manufacturers: Grayhill, Inc. Description: DC OUTPUT MODULE 3A Ao amin'ny staoky: 7355 pcs</p> <p>RFQ</p>
 <p>70M-OAC5-L Manufacturers: Grayhill, Inc. Description: AC OUTPUT MODULE 3A Ao amin'ny staoky: 8392 pcs</p> <p>RFQ</p>	 <p>70M-ODC5R Manufacturers: Grayhill, Inc. Description: DC OUTPUT MODULE 500MA Ao amin'ny staoky: 4717 pcs</p> <p>RFQ</p>
 <p>70M-ODC5 Manufacturers: Grayhill, Inc. Description: DC OUTPUT MODULE 3A Ao amin'ny staoky: 8047 pcs</p> <p>RFQ</p>	 <p>70M-ODC5A Manufacturers: Grayhill, Inc. Description: DC OUTPUT MODULE 3A Ao amin'ny staoky: 4170 pcs</p> <p>RFQ</p>